

Description

This source terminator network provides high performance resistor termination for high-speed data busses.

Designed with a ceramic substrate, this device minimizes channel capacitance, a primary cause of reduced system performance. In addition, the BGA package eases routing design, saving the designer many hours of printed circuit layout.

The BGA packaging has been proven to reduce rework and improve reliability.

Features

- 16 or 32 Bit Terminators
- Ultra Low I/O Coupling
- Slim BGA Package
- $\pm 1\%$ Resistor Tolerance
- Top Side Probe-able Version Available for Development
- RoHS Compliant Designs Available
 - Compatible with both lead and lead free processes

Style C

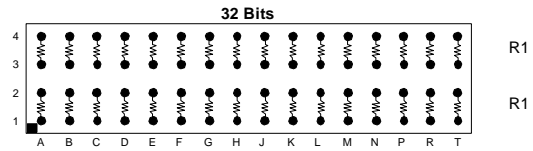
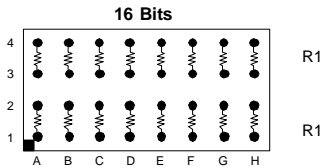

Electrical Specifications

Resistor Tolerance:	$\pm 1.0\%$
TCR	$\pm 200\text{ppm}/^\circ\text{C}$
Operating Temperature Range	-55°C to $+125^\circ\text{C}$
Maximum Resistor Power:	0.05 Watts at 70°C
Maximum Package Power:	1.0 Watts at 70°C
Process Requirements:	
Maximum Temperature	Per IPC/JEDEC J-STD-020C

Typical Application

DRAM Series Termination for Address Lines

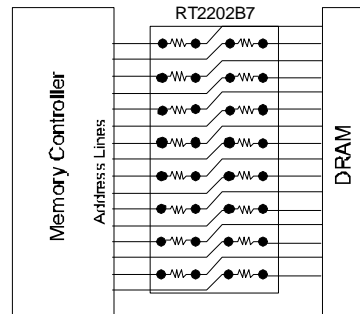

Ordering Information

1.00mm Pitch Standard Part No.	Style	R1 Ω	Bits	Array Size	1.00mm Pitch RoHS Part No.
RT1200B7*	C	10	16	4 x 8	RT2200B7*
RT1202B7	C	33	16	4 x 8	RT2202B7
RT1232B7	C	22	16	4 x 8	RT2232B7
RT1233B7	C	25	16	4 x 8	RT2233B7
RT1235B7	C	50	16	4 x 8	RT2235B7
RT1201B7*	C	10	32	4 x 16	RT2201B7*
RT1203B7	C	33	32	4 x 16	RT2203B7
RT1205B7*	C	50	32	4 x 16	RT2205B7*
RT1236B7	C	100	32	4 x 16	RT2236B7

* - Indicates Top Side Probable versions available.

Packaging Information

Suffix	TR7	TR13
Tape Width	24 mm	24mm
Carrier Pitch	8 mm	8 mm
Reel Diameter	7 inch	13 inch
Parts/Reel	1,000	4,000

Part Number Coding

7 inch reel, Add TR7 to part number, example RT2400B6TR7

13 inch reel, Add TR13 to part number, example RT2400B6TR13

(Bulk packaging is not available)

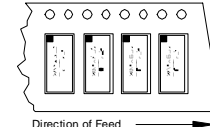

Recommended Land Pattern

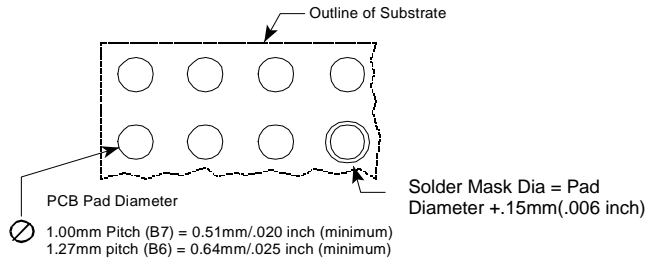

For .006" Thick Solder Paste Stencil, Aperture Opening Should be Equal to the PCB Pad Diameter.

Refer to www.ctscorp.com/components/clearone.asp for additional PCB design information

BGA Routing Scheme

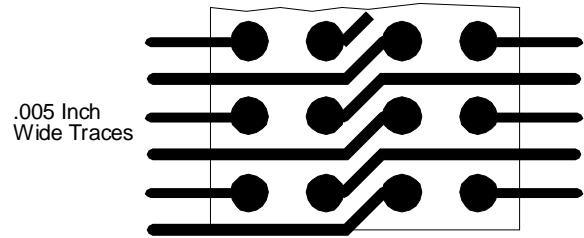

Top Side Probe-able Information

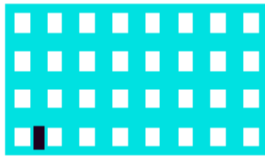

Top Side Probe-able Probe Pad 4x8 Array Shown

Refer to Top Probe-able Application Notes for additional information.

DIM METRIC/ENGLISH	"PITCH SUFFIX"	
	B6	B7
"A"	0.64/.025	0.50/.020
"B"	1.27/.050	1.00/.039
"C"	0.64/.025	0.50/.020
"D"	0.66/.026	0.50/.020
"E"	0.71/.028	0.28/.011
"F"	0.66/.026	0.66/.026

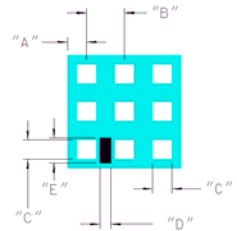

Note: Add a 'P' suffix to order Top Side Probe-able version.

Example: RT2203B7PTR7.

Refer to the following link for detailed Top Side Probe-able Information:

www.ctscorp.com/components/clearone/TopProveClearOne.pdf

Mechanical Diagram

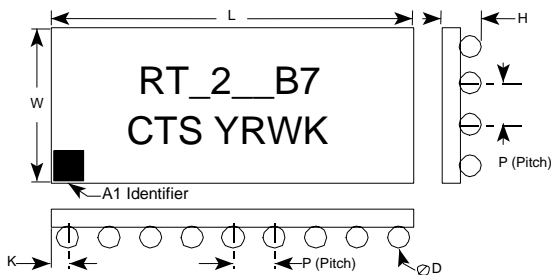

16 Bit		L	W	H	P	D	K
Style C	mm	8.00±0.15	4.00±0.15	1.19±0.15	1.00±0.25	0.64±0.05	0.50±0.25
	inch	.315±.006	.157±.006	.047±.006	.039±.010	.025±.002	.020±.010
32 Bit		L	W	H	P	D	K
Style C	mm	16.00±0.15	4.00±0.15	1.19±0.15	1.00±0.25	0.64±0.05	0.50±0.25
	inch	.630±.006	.157±.006	.047±.006	.039±.010	.025±.002	.020±.010

Complete ClearONE Product, Processing, and Application Information can be found at the following link:

<http://www.ctscorp.com/components/clearone.asp>