

MC1710 MC1710C



DIFFERENTIAL VOLTAGE COMPARATORS

...designed for use in level detection, low-level sensing, and memory applications.

- Differential Input Characteristics –
Input Offset Voltage = 1.0 mV – MC1710
= 1.5 mV – MC1710C
Offset Voltage Drift = 3.0 $\mu\text{V}/^\circ\text{C}$ – MC1710
= 5.0 $\mu\text{V}/^\circ\text{C}$ – MC1710C
- Fast Response Time – 40 ns
- Output Compatible with all Saturating Logic Forms –
 $V_O = +3.2\text{ V to } -0.5\text{ V (Typ)}$
- Low Output Impedance – 200 Ohms

DIFFERENTIAL COMPARATORS SILICON MONOLITHIC INTEGRATED CIRCUIT

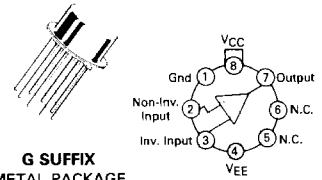

G SUFFIX
METAL PACKAGE
CASE 601-04

MAXIMUM RATINGS ($T_A = +25^\circ\text{C}$ unless otherwise noted.)

Rating	Symbol	Value	Unit	
Power Supply Voltage	$V_{CC(\text{max})}$	+14	Vdc	
	$V_{EE(\text{max})}$	-7.0	Vdc	
Differential Input Signal Voltage	V_{ID}	± 5.0	Volts	
Common Mode Input Swing Voltage	V_{ICR}	± 7.0	Volts	
Peak Load Current	I_L	10	mA	
Power Dissipation (Package Limitations)	P_D	680	mW	
		Derate above $T_A = +25^\circ\text{C}$	4.6	mW/ $^\circ\text{C}$
	Ceramic Dual In-Line Package	625	mW	
		Derate above $T_A = +25^\circ\text{C}$	5.0	mW/ $^\circ\text{C}$
Operating Temperature Range	T_A	MC1710	-55 to +125	$^\circ\text{C}$
		MC1710C	0 to +75	$^\circ\text{C}$
Storage Temperature Range	T_{stg}	-65 to +150	$^\circ\text{C}$	

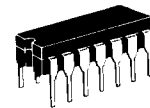

L SUFFIX
CERAMIC PACKAGE
CASE 632-02
MO-001AA

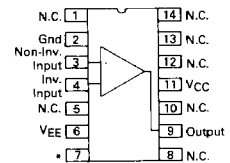

*Connected to pin 6 via the substrate on some plastic units.

EQUIVALENT CIRCUIT

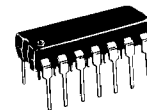
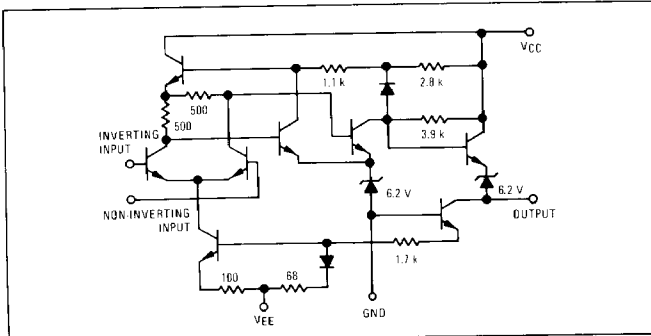

P SUFFIX
PLASTIC PACKAGE
CASE 646-05
(MC1710C Only)

MC1710, MC1710C

ELECTRICAL CHARACTERISTICS ($V_{CC} = +12$ Vdc, $V_{EE} = -6.0$ Vdc, $T_A = +25^\circ\text{C}$ unless otherwise noted.)

Characteristic	Symbol	Min	Typ	Max	Unit	
Input Offset Voltage ($V_O = 1.4$ Vdc, $T_A = +25^\circ\text{C}$)	V_{IO}	MC1710	—	1.0	2.0	mVdc
		MC1710C	—	1.0	5.0	
($V_O = 1.8$ Vdc, $T_A = -55^\circ\text{C}$)		MC1710	—	—	3.0	
($V_O = 1.0$ Vdc, $T_A = +125^\circ\text{C}$)		MC1710	—	—	3.0	
($V_O = 1.5$ Vdc, $T_A = 0^\circ\text{C}$)		MC1710C	—	—	6.5	
($V_O = 1.2$ Vdc, $T_A = +75^\circ\text{C}$)		MC1710C	—	—	6.5	
Temperature Coefficient of Input Offset Voltage	$\Delta V_{IO}/\Delta T$	—	3.0	—	$\mu\text{V}/^\circ\text{C}$	
Input Offset Current ($V_O = 1.4$ Vdc, $T_A = +25^\circ\text{C}$)	I_{IO}	MC1710	—	1.0	3.0	μAdc
		MC1710C	—	1.0	5.0	
($V_O = 1.8$ Vdc, $T_A = -55^\circ\text{C}$)		MC1710	—	—	7.0	
($V_O = 1.0$ Vdc, $T_A = +125^\circ\text{C}$)		MC1710	—	—	3.0	
($V_O = 1.5$ Vdc, $T_A = 0^\circ\text{C}$)		MC1710C	—	—	7.5	
($V_O = 1.2$ Vdc, $T_A = +75^\circ\text{C}$)		MC1710C	—	—	7.5	
Input Bias Current ($V_O = 1.4$ Vdc, $T_A = +25^\circ\text{C}$)	I_{IB}	MC1710	—	12	20	μAdc
		MC1710C	—	12	25	
($V_O = 1.8$ Vdc, $T_A = -55^\circ\text{C}$)		MC1710	—	—	45	
($V_O = 1.0$ Vdc, $T_A = +125^\circ\text{C}$)		MC1710	—	—	20	
($V_O = 1.5$ Vdc, $T_A = 0^\circ\text{C}$)		MC1710C	—	—	40	
($V_O = 1.2$ Vdc, $T_A = +75^\circ\text{C}$)		MC1710C	—	—	40	
Voltage Gain ($T_A = +25^\circ\text{C}$)	A_{vol}	MC1710	1250	1700	—	V/V
		MC1710C	1000	1700	—	
(1) ($T_A = T_{low}$ to T_{high})		MC1710	1000	—	—	
		MC1710C	800	—	—	
Output Resistance	r_o	—	200	—	Ohms	
Differential Voltage Range	V_{ID}	± 5.0	—	—	Vdc	
Positive Output Voltage ($V_{ID} \geq 5.0$ mV, $0 \leq I_O \leq 5.0$ mA)	V_{OH}	2.5	3.2	4.0	Vdc	
Negative Output Voltage ($V_{ID} \geq -5.0$ mV)	V_{OL}	-1.0	-0.5	0	Vdc	
Output Sink Current ($V_{ID} \geq -5.0$ mV, $V_O \leq 0$)	I_{Os}	MC1710	2.0	2.5	—	mA _{dc}
		MC1710C	1.6	2.5	—	
(1) ($V_{ID} \geq -5.0$ mV, $V_O \geq 0$, $T_A = T_{low}$)		MC1710	1.0	2.0	—	
		MC1710C	0.5	—	—	
Input Common-Mode Voltage Range ($V_{EE} = -7.0$ Vdc)	V_{ICR}	± 5.0	—	—	Volts	
Common-Mode Rejection Ratio ($V_{EE} = -7.0$ Vdc, $R_S \leq 200$ Ohms)	CMRR	MC1710	80	100	—	dB
		MC1710C	70	100	—	
Propagation Delay Time for Positive and Negative Going Input Pulse ($V_{ID} = 5.0$ mV + V_{IO})	t_{PLH} t_{PHL}	—	40 35	—	ns	
Power Supply Current ($V_O \leq 0$)	I_{D^+} I_{D^-}	—	6.4 5.5	9.0 7.0	mA _{dc}	
Power Consumption	P_D	—	115	150	mW	

(1) $T_{low} = -55^\circ\text{C}$ for MC1710, 0°C for MC1710C
 $T_{high} = +125^\circ\text{C}$ for MC1710, $+75^\circ\text{C}$ for MC1710C

TYPICAL CHARACTERISTICS

FIGURE 1 – VOLTAGE TRANSFER CHARACTERISTICS

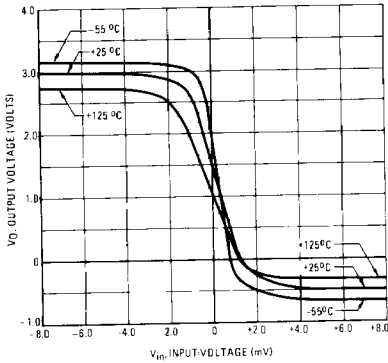

FIGURE 2 – INPUT OFFSET VOLTAGE versus TEMPERATURE

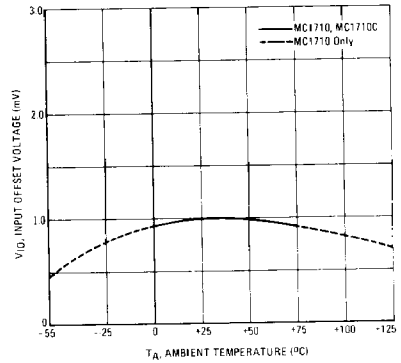

FIGURE 3 – INPUT OFFSET CURRENT versus TEMPERATURE

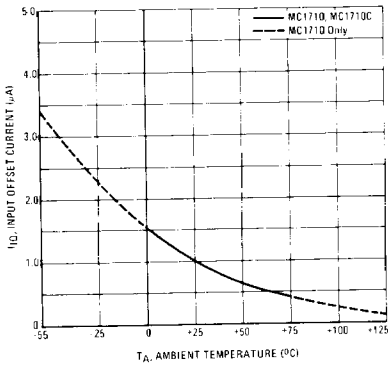

FIGURE 4 – INPUT BIAS CURRENT versus TEMPERATURE

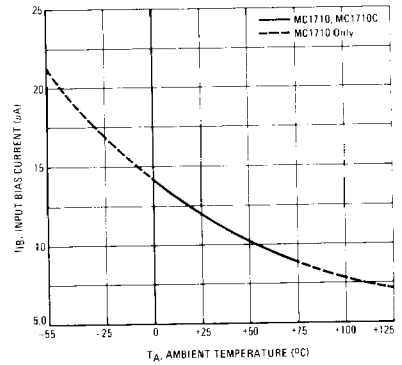

FIGURE 5 – GAIN VARIATION WITH POWER SUPPLY VOLTAGE

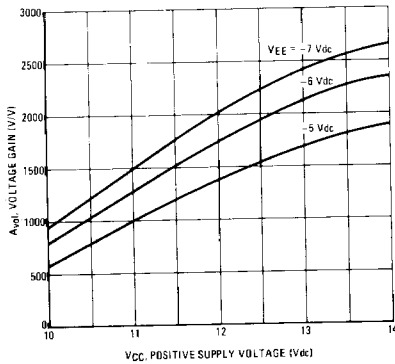
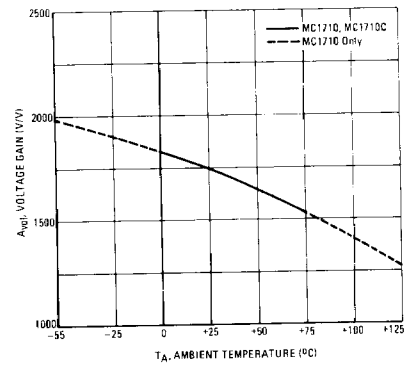

FIGURE 6 – VOLTAGE GAIN versus TEMPERATURE



8

TYPICAL CHARACTERISTICS (Continued)

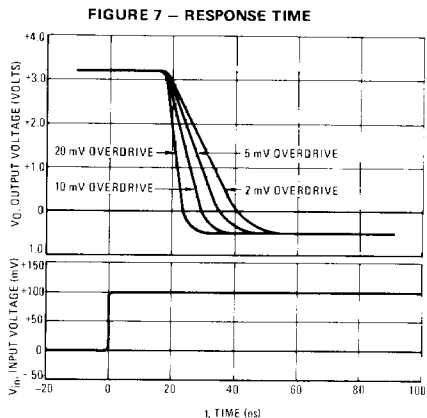

FIGURE 8 – POWER DISSIPATION versus TEMPERATURE

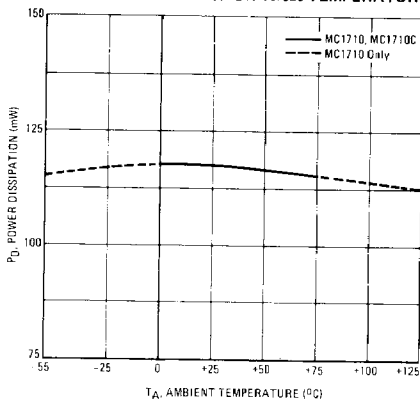

FIGURE 9 – RECOMMENDED SERIES RESISTANCE versus MRTL LOADS

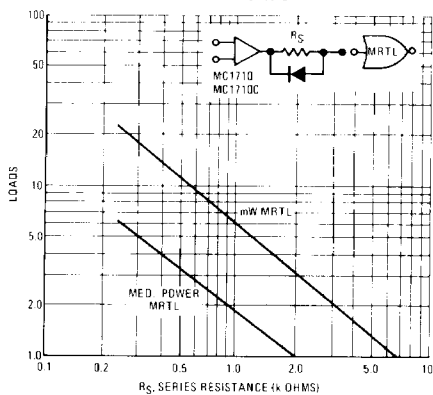

FIGURE 10 – FAN-OUT CAPABILITY WITH MDTL OR MTTL OUTPUT SWING

